

Primljen / Received: 27.2.2017.

Ispravljen / Corrected: 30.4.2018.

Prihvaćen / Accepted: 21.2.2019.

Dostupno online / Available online: 10.6.2019.

Design limits for intersection angles between approach legs of suburban roundabouts

Authors:



Assist.Prof. **Ivica Stančerić**, PhD. CE
University of Zagreb
Faculty of Civil Engineering
istanceric@grad.hr



Assist.Prof. **Saša Ahac**, PhD. CE
University of Zagreb
Faculty of Civil Engineering
sahac@grad.hr



Šime Bezina, MCE
University of Zagreb
Faculty of Civil Engineering
sbezina@grad.hr



Filip Vlaović, MCE
Vodoprivreda Nova Gradiška d.d.
filip-vlaovic@hotmail.com

Subject review

Ivica Stančerić, Saša Ahac, Šime Bezina, Filip Vlaović

Design limits for intersection angles between approach legs of suburban roundabouts

Roundabout design guidelines typically offer a step-by-step design process for roundabouts with four approach legs that intersect at right angle in the centre of the central island. If the angle between the approaches is skewed, it is recommended to realign either one or more approach legs. The design limits for intersection angles (i.e. the alignments that do not require repositioning of the approaches) are not listed in most relevant guidelines. This research, conducted in order to define these design limits, is based on theoretical examples of suburban roundabouts with different approach angles and outer radii, designed according to current Croatian and German guidelines.

Key words:

roundabouts, intersection angle limits, design vehicle

Pregledni rad

Ivica Stančerić, Saša Ahac, Šime Bezina, Filip Vlaović

Granični kutovi presijecanja osi privoza na izvangradskim kružnim raskrižjima

Smjernice za projektiranje kružnih raskrižja u pravilu prikazuju postupak oblikovanja četverokrakih kružnih raskrižja za slučaj u kojem se osi privoza sijeku pod pravim kutom. Ako taj kut odstupa od pravog, preporučuje se rekonstrukcija osi privoza. Granični kutovi do kojih nije potrebno rekonstruirati osi u većini dokumenata vezanih uz elemente oblikovanja kružnih raskrižja nisu navedeni. Radi definiranja tih graničnih kutova provedeno je ispitivanje mogućnosti oblikovanja kružnih raskrižja za različite kutove presijecanja osi privoza na shemama raskrižja oblikovanih prema hrvatskim i njemačkim smjernicama.

Ključne riječi:

kružna raskrižja, granični kutovi presijecanja osi cesta, mjerodavno vozilo

Übersichtsarbeit

Ivica Stančerić, Saša Ahac, Šime Bezina, Filip Vlaović

Grenzwinkel der Achsenüberschneidung der Kreuzungszufahrt bei Kreisverkehren außerhalb der Stadt

Die Richtlinien für die Planung von Kreisverkehren stellt in der Regel ein Verfahren der Gestaltung von Kreisverkehren mit vier Zufahrten dar, für den Fall, in dem die Zufahrtsachsen unter einem rechten Winkel überschritten werden. Sollte dieser Winkel vom rechten Winkel abweichen, empfiehlt man die Rekonstruktion der Zufahrtsachse. Die Grenzwinkel bis zu denen eine Rekonstruktion der Achsen nicht notwendig ist, werden in den meisten Unterlagen in Bezug auf die Elemente der Gestaltung von Kreisverkehren nicht angeführt. Zur Definition dieser Grenzwinkel wurde eine Untersuchung der Möglichkeiten der Gestaltung von Kreisverkehren für unterschiedliche Überschneidungswinkel der Zufahrtsachsen an den Schemata der Kreuzungen, die gemäß den kroatischen und deutschen Richtlinien gestaltet wurden, durchgeführt.

Schlüsselwörter:

Kreisverkehr, Grenzwinkel der Überschneidungsachse der Straße, maßgebendes Fahrzeug

1. Introduction

Roundabouts have been intensively built in Europe over the last two decades. European countries that have the greatest number of roundabouts are France (27,000 to 30,000) [1], the Netherlands (3,500) and United Kingdom (25,000) [2]. Countries like Sweden, Switzerland, Denmark, Finland, Germany, and Austria have also adopted the policy of their mass implementation in the traffic network. Gradual increase in the number of roundabouts can also be seen in Croatia [3]. Extensive research has been conducted in the mentioned period to increase traffic capacity and safety at roundabouts [4, 5]. It has been revealed during these research activities that significant safety problems are present on traditional roundabouts with two or more circular lanes [6] and, therefore, alternative type of roundabouts, such as "hamburger", "dumb-bell" and "turbo-roundabouts" have become a common solution for traffic intersections [7-14].

An optimum roundabout design depends on the width of circulatory roadway as related to the alignment and shape of approach legs. The alignment of approach legs affects the curvature of the design vehicles' paths and the sight distance between neighbouring legs. Although the number of (national) guidelines and regulations for the design of traditional and alternative roundabouts is on the rise, most of them give instructions for the most favourable position of roundabouts' approach legs, in which their axes intersect at right angle in the centre of the central island [15-21]. The most common recommendation for intersections with skewed angle between approach legs is the realignment of the approaches. However, sometimes the realignment is not possible due to spatial constraints: development of the surrounding area or the inability to purchase additional land. Croatian [15] and international [16, 17] guidelines do not provide specific information about design limits for intersection approach angles. Because of that, approach axes are often realigned on all roundabouts with skewed approach angles, even in cases when this intervention is unnecessary. This is understandable, because the process of determining the limit angles, i.e. the alignments that do not require repositioning of approaches, is iterative and time-consuming.

The goal of the research presented in this paper is to determine design limits for suburban, single-lane, four-leg roundabouts while considering different intersection angles between approach axes. The motivation for the research is the need for achieving maximum reliability and efficiency in the design of such roundabouts. One of fundamental prerequisites for the good-quality roundabout design is to ensure proper conditions for an unobstructed passage of design vehicles. This can easily be achieved thanks to present-day development of the vehicle movement simulation software that allows easier and faster definition and modification of design vehicle movement trajectories. This research is based on simulation of design vehicle movement by means of the swept path analysis software "Vehicle Tracking" [22]. The research was conducted on theoretical roundabout schemes designed according to Croatian [15] and German guidelines [17, 18]. German guidelines were selected

because they were commonly used for roundabout design in the Republic of Croatia before the year 2014, due to the lack of national regulations. This research will indicate which of these two guidelines is more flexible in terms of design parameters for roundabouts with skewed intersecting angles of approach legs.

2. Current state of the art

The allowed deviation from the right angle between roundabout approaches depends on the design vehicle swept path (because this path affects the entrance and exit lane widths as well as other roundabout design elements), requirements for stopping sight distance, and fastest path tests results. Guidelines and regulations provide the following instructions in the context of intersection angle limits, i.e. the alignment of the approaches on roundabouts. According to the AASHTO Green Book [23], the maximum allowable deviation from the right angle is 30° on four-leg intersections. This means that all intersection angles between axes within this range (60° to 120°) are considered as being the right angle in the procedure of examining the stopping sight distance and calculating the traffic capacity on the intersections. Studies conducted in the past decade [24-30] have shown that the deviation from the right angle must be reduced to 25° in order to meet the sight distance requirements on intersections. Most of these studies [24-29] deal with classic intersections. Nevertheless, their results can be applied to roundabouts because they investigate the field of view of drivers (young and old, professional and non-professional) and visibility obstructions (namely the position of A and B pillars) for various types of vehicles. These parameters have a significant impact on intersection angle limits and are not dependent on the intersection type.

According to Croatian guidelines [15], it is desirable that the approach axes intersect at one point near the centre of the central island (Figure 1a). The approach axes on suburban intersections should intersect at right angle (Figure 1a, approach A) or approximately at right angle (Figure 1a, approaches B and C). In addition, the angle between two approach axes on roundabouts must be large enough so that the outer edge of the approach roadway and the outer edge of the circulatory roadway are not formed of a single arc (Figure 1b). It can be concluded that, according to Croatian guidelines [15], the limit angle between the approaches depends on the location of the roundabout, the size of its outer radius, and on design elements of approach legs (roundabout entrance and exit widths and radii).

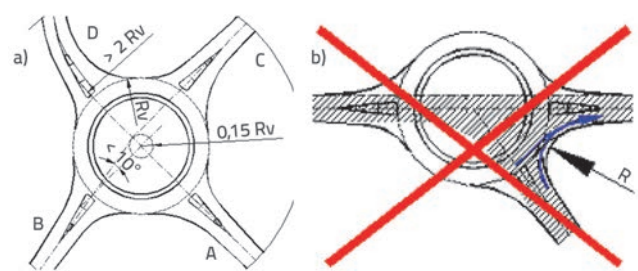

Figure 1. Approach alignment on roundabouts according to Croatian guidelines [15]

According to German guidelines [17], basic principles for a safe roundabout design can be summarised as follows: approach axes should intersect at an angle which is as close as possible to the right angle, and proper deflection conditions should be ensured (vehicle path through the roundabout, i.e. path around the central island must be curved, as shown in Figure 2). German guidelines do not provide information about the limitation of the angle between approach axes, but the definition of deflection terms suggests caution in the alignment of the approaches.

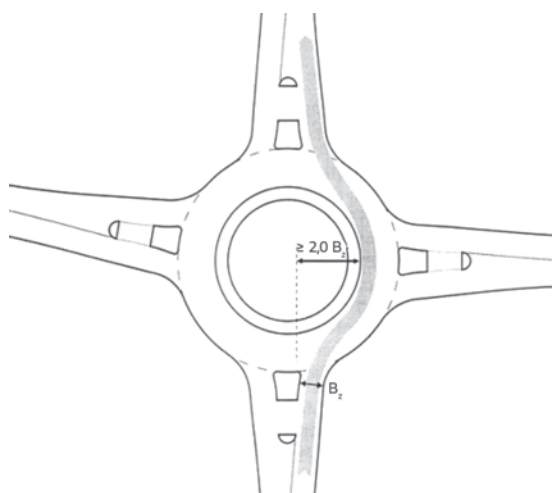

Figure 2. Deflection criterion according to German guidelines [17]

Input parameters and research results on theoretical schemes of roundabouts designed according to Croatian [15] and German guidelines [17, 18] are presented below. As mentioned earlier, the results will indicate which of these two guidelines is more flexible in terms of design parameters for roundabouts with skewed angle of approach legs. The results will also show allowable deviations of approach axes angles from the right angle in terms of roundabout operation and safety requirements.

3. Roundabout design

Roundabout design is an iterative process, and Croatian [15] and German guidelines [17, 18] coincide in most of its steps. These steps are listed in Table 1, together with recommended and limit values of roundabout design elements (Figure 3).

3.1. Determination of circulatory roadway width

According to Croatian guidelines [15], the width of the circulatory roadway and truck apron ($u + u'$) is determined based on the swept path width ($\Delta v' + sv$) of the design vehicle on circulatory roadway, and protective lateral widths (z and zu) (Figures 3 and 4). The inner radius ($R_{i'}$) of the central island is defined based on the outer radius (R_o) and the circulatory roadway width ($u + u'$). On national roads, central island truck aprons are mandatory, and the minimum width is 1.0 m [15].

Table 1. Roundabout design steps with recommended and limit values of design elements according to Croatian [15] and German guidelines [17, 18]

Step	Description	Croatian guidelines	German guidelines
1	Selection of roundabout size	Outer radius (R_v): 11.0 - 25.0 m (13.5 - 22.5 m)	Diameter (D): 35.0 - 45.0 m (30.0 - 50.0 m)
2	Selection of circular roadway and truck apron width	The width of the circulatory roadway (u) should be determined based on the swept path width of the design two-axle vehicle (Figures 3 and 4). The width of the truck apron (u') should be determined based on the swept path width of the design three-axle truck with three-axle semi-trailer or two-axle trailer (Figures 3 and 4)	Circular roadway width (BK): 8.0 - 6.5 m Design of truck apron on suburban roundabouts is not mandatory
3	Selection of approach lane width	Approach lane width (v): 3.0 - 3.5 m (2.5 - 7.0 m)	Approach lane width (BZ): 3.5 - 4.0 m (4.5 - 5.0) m
4	Selection of splitter island shape	Possible shapes: triangular (length (m): 15.0 - 50.0 m), elongated with parallel sides, funnel shaped	Possible shapes: triangular, elongated with parallel sides, elephant foot shape
5	Selection of entrance width	Entrance width (e): 4.0 - 7.0 m (3.6 - 10.0 m)	-
6	Selection of outer roadway edge radius on entry	Entry radius (R_{ul}): 8.0 - 20.0 m (6.0 - 25.0 m)	Entry radius (R_z): 14.0 - 16.0 m
7	Selection of exit width	Exit width (e'): 4.0 - 7.0 m (3.6 - 10.0 m)	Exit lane width (B_A): 3.75 - 4.50 (4.75 - 5.50) m
8	Selection of outer edge radius on exit	Exit radius (R_{iz}): 10 - 25 m (8 - 50 m)	Exit radius (R_A): 16.0 - 18.0 m
9	Control of roundabout geometry	Entry angle (Φ): 0 - 77° (20 - 40°) Widening severity (S): 0 - 2.9	Vehicle path deflection must be equal or larger than $2B_z$ (Figure 2)
10	Selection of design vehicle	Possible design vehicles: semitrailer truck (Figure 4), truck with trailer	Possible design vehicles: 13 design vehicles [31]
11	Swept path control	Protective lateral widths along the swept path (z and zu): 1.0 and 0.5 m (Figure 4)	Protective lateral width along swept path: 0.5 m

(values in brackets) - limit values

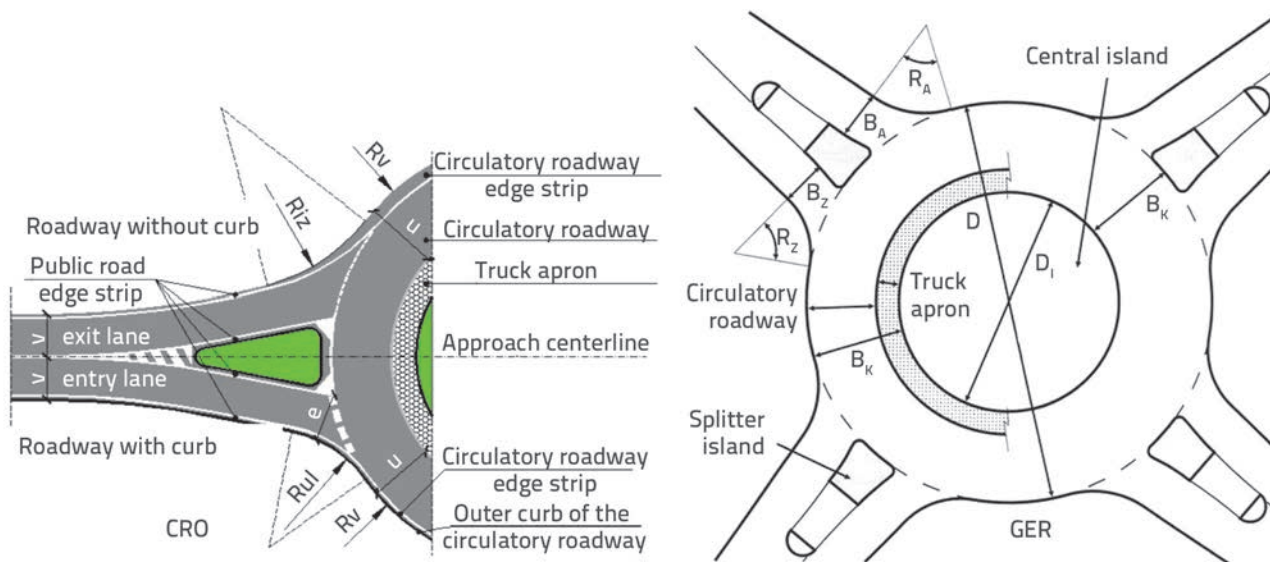

Figure 3. Roundabout design elements according to Croatian [15] and German guidelines [17]

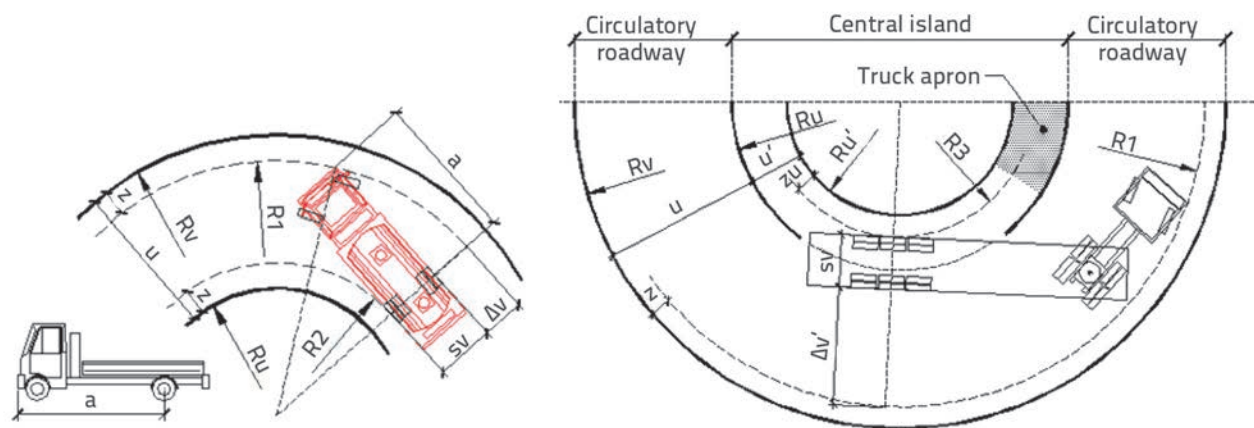

Figure 4. Determination of circulatory roadway and truck apron width [15]

According to German guidelines [17], the circulatory roadway width (B_K), with or without truck apron (Figure 3), is inversely proportional to the roundabout diameter (D). If the roundabout diameter (D) is greater than or equal to 40 m, the circulatory roadway width is 6.5 m, while on roundabouts 30 m in diameter the circulatory roadway is 8.0 m wide. The design of truck aprons is not mandatory on suburban roundabouts.

3.2. Design of outer roadway edge at roundabout entrance and exit

According to Croatian guidelines [15], main preconditions for an unobstructed vehicle movement at roundabout entrance and exit are: proper design of the outer roadway edge at entrance and exit, and selection of the following design elements: entry and exit radii (R_{1i} and R_{1z}), entrance and exit widths (e , e'), and circulatory roadway width (u). The outer roadway edge can be designed in two different ways:

- with a shorter effective roadway widening length (l') - the outer roadway edge is composed of circular arc and straight line which is parallel to the side of the triangular splitter island (Figure 5.a),
- with a longer effective roadway widening length (l') - the outer roadway edge is composed of circular arc and straight line which is not parallel to the side of the triangular splitter island (Figure 5.b).

Croatian guidelines [15] do not offer any information on when to use either procedure (a) or (b) for the design of roadway widening on roundabout entrances and exits. Therefore, the designer has to decide on the procedure that will ensure an unobstructed vehicle movement. This decision must be based on the design vehicle swept path analysis. In our experience, the shorter effective roadway widening length (procedure (a)) should not be used when a semi-trailer truck is chosen as a design vehicle, because this procedure can result in larger entrance and exit

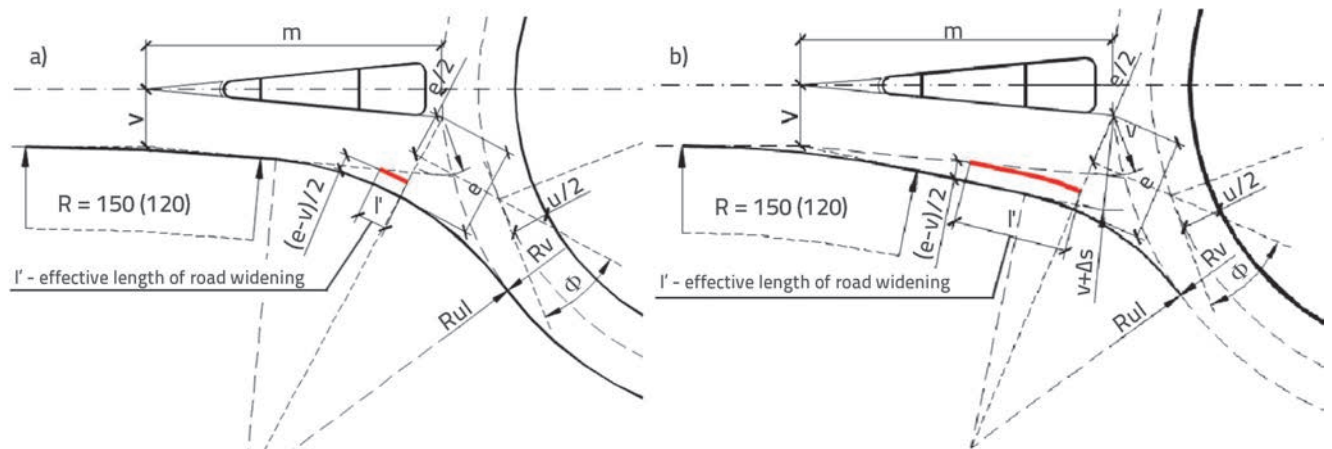

Figure 5. Outer roadway edge design and entry angle determination [15]

widths [32, 33]. Because of that, the application of the longer effective roadway widening length (procedure (b)) is advisable: this outer roadway edge is better adapted to the design vehicles' swept path, i.e. outer trajectory.

In terms of the entry to exit radius ratio, Croatian guidelines [15] recommend that the exit radius should be greater than or equal to the entry radius. The roundabout exit width (e') depends on the swept path width made by the design vehicle. The recommended values of the exit width (e') are given in Table 1. The recommended values of the entry (R_e) and exit (R_a) radius of the outer edge of the roadway (Figure 3) according to German guidelines [17, 18] are given in Table 1. These values can be greater on the suburban roundabouts in order to facilitate passage of longer design vehicles.

3.3. Splitter island design

Splitter islands on the approaches are a mandatory part of roundabouts as they enable separation of opposite traffic flows. According to Croatian guidelines [15], the shape and dimensions of splitter islands (Figures 3 and 5) depend on traffic needs (entrance angle and radius, pedestrian and/or bicycle traffic, traffic signs, and swept path analysis). The start of marked pavements on approaches to suburban roundabouts should be at a distance greater or equal to 25 m from the outer edge of the circulatory roadway (Figures 3 and 5). A triangular splitter island

is usually designed at suburban roundabouts with the diameter of less than 50 m, and when higher entrance speeds are not allowed (Figures 3 and 5).

According to German guidelines [17, 18], splitter islands on approaches are usually in form of an elephant's foot (Figure 3). The width of the island is at least 1.6 m if there are no pedestrians and cyclists.

3.4. Roundabout geometry control

According to Croatian guidelines [15], the following design elements should be checked after selection of basic roundabout design elements: effective roadway widening length (l'), entry angle, (Φ) and widening severity (S). The roundabout entrance width (e), the effective roadway widening length at the entrance (l'), the widening severity (S), and the entry angle (Φ), are the result of the splitter island design, adopted entry radius (R_u), and roadway widening (Figures 6 and 8).

The effective roadway widening length (l') is the length at which an average effective widening ($(e-v)/2$) is realized. On suburban roundabouts, that length must be at least equal to the length of the separation area (m) between opposite traffic flows (Figures 3 and 5). The entry angle (Φ) is the tangent angle between two trajectories, the trajectory of a vehicle on the roundabout entrance and the trajectory of a vehicle on the roundabout circulatory roadway (Figure 6). To determine the entry angle, it is necessary

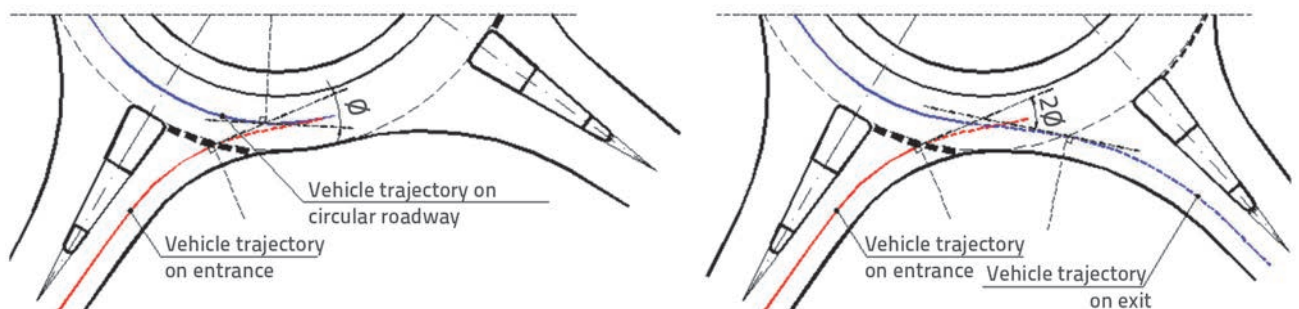

Figure 6. Entry angle (Φ) construction procedure [15]

to construct the expected vehicle movement trajectories at the roundabout entrance, and on the neighbouring exit, if the adjacent exit is near the observed entrance. The entry angle is measured between the tangents of expected trajectories as shown in Figures 5 and 6. The limit and recommended values of entry angles are given in Table 1. The dimensionless roadway widening severity (S) is calculated according to the following Eq. (1):

$$S = \frac{1,6 \cdot (e - v)}{l'} \tag{1}$$

where e [m] is the roundabout entrance width, v [m] is the approach roadway lane width, and l' [m] is the effective roadway widening length. The limit and recommended values for (S) are given in Table 1.

According to German guidelines [17], the following roundabout geometry features, which influence deflection around the central island, should be checked: the entrance lane width (B₂) and the distance between the edge of the central island and the line that goes from the right side of the splitter island at the access road (measured at the tangent point, as shown in Figure 2). If the distance is greater or equal to double entrance lane width (2B₂), the roundabout deflection and overall design is considered satisfactory.

3.5. Design vehicles and swept path analysis

According to Croatian guidelines [15], the roundabout swept path analysis can be performed for two design vehicles: semi-trailer truck (16.5 m long) and truck with trailer (18.75 m long). Dimensions of these vehicles comply with the corresponding EU Directive [34], as shown in Figure 7.

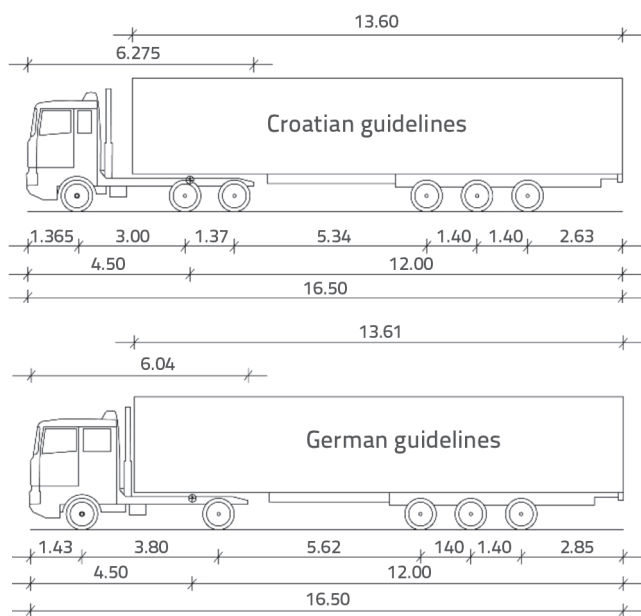

Figure 7. Design vehicle according to Croatian [15] and German guidelines [31]

The swept path analysis is conducted by drawing the design vehicle (body) movement trajectories for all directions on the roundabout plan, as shown in Figure 8. This ensures that conditions for an unobstructed vehicle movement at roundabout entrance and exit are achieved.

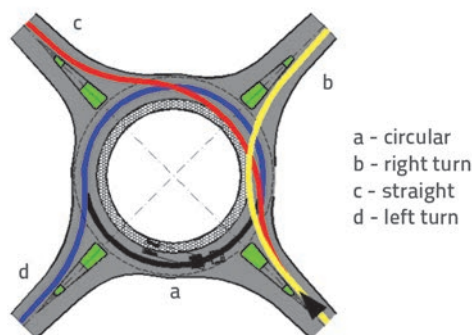

Figure 8. Movement directions of design vehicles [12]

The minimum protective lateral width along trajectories (z_v) is 0.5 m (exceptionally 0.3 m) on all segments, except at the outer edge of the circulatory roadway where the minimum lateral width (z) is 1.0 m (Figure 4). Protective widths provide additional space for smooth passage of vehicles that are not using the designed movement path. Guidelines also suggest that the design and construction of the truck apron be mandatory on small and medium-sized roundabouts (R_v = 11.0 – 25.0 m) so as to provide for an unobstructed passage of long vehicles (Figure 4). The minimum truck apron width is 1.0 m.

According to German guidelines [31], thirteen design vehicles (buses, trucks, semi-trailer truck, truck with trailer, etc.) are specified for the swept path analysis. Dimensions of these vehicles comply with the corresponding EU Directive [34]. It is not specified in the roundabout design guidelines [17, 18] which design vehicle should be used for the swept path analysis on roundabouts. The swept path analysis procedure is the same as the one prescribed in Croatian guidelines [15], the only difference being in the minimum protective lateral width along the trajectories, which is 0.5 m on all segments of the roundabout. As to the need to ensure an unobstructed passage of long vehicles and truck apron design, German guidelines [17, 18] do not require construction of truck aprons on suburban roundabouts (the designed width of circulatory roadway should provide for unobstructed passage of such vehicles).

4. Research

The research presented in this paper was carried out on various schemes of suburban, four-leg, single-lane roundabouts, designed according to Croatian [15] and German [17, 18]

guidelines for the semi-trailer truck design vehicle 16.5 m in length (Figure 7). The initial roundabout design scheme was created based on the following input data (Figure 9):

- angles between approach axes ranged from 65 to 115°, with a 5° increment;
- roundabouts outer radii ($R_v = D/2$) ranged from 15 to 25 m, with a 2.5 m increment;
- splitter islands on approaches were 30 meters long and shaped according to the corresponding guidelines: at roundabouts designed according to Croatian guidelines [15] islands were triangular with a side slope of 1:15, and at roundabouts designed according to German guidelines [17, 18] islands were in form of an elephant foot.

Circulatory roadway and truck apron widths ($u + u'$) for roundabouts designed according to Croatian guidelines [15] were defined based on the swept path analysis of a design vehicle moving along the circulatory roadway with a radius (R_1). The radius (R_1) corresponds to the outer roundabout radius (R_v), reduced by protective lateral width ($z = 1.0$ m) (Table 2). Widths of circulatory roadways (B_k) at roundabouts designed according to German guidelines were determined based on outer radii ($R_v = D/2$) (Table 2).

Swept path analyses were conducted using the Vehicle Tracking software [22] for all roundabout schemes and in all directions of movement of the design vehicle (right, straight, left and circular).

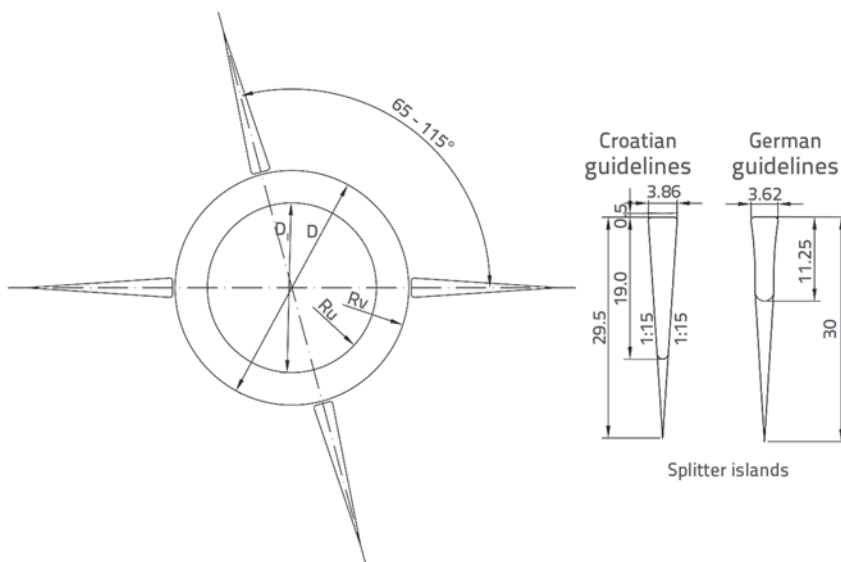

Figure 9. Initial roundabout scheme

Table 2. Circulatory roadway width

Outer radius ($R_v = D/2$ [m])		15.0	17.5	20.0	22.5	25.0
Croatian guidelines	R_1 [m]	14.0	16.5	19.0	21.5	24.0
	$(sv + \Delta v')$ [m]	6.60	5.70	5.20	4.80	4.60
	$(sv + \Delta v' + z + zu)$ [m]	8.10	7.20	6.70	6.30	6.10
	$(u + u')$ [m]	8.25	7.25	6.75	6.50	6.25
German guidelines	B_k [m]	8.00	7.00	6.50	6.50	6.50

Roadway edges at the entrances and exits of roundabouts were formed based on these movement trajectories (Figures 10 and 11).

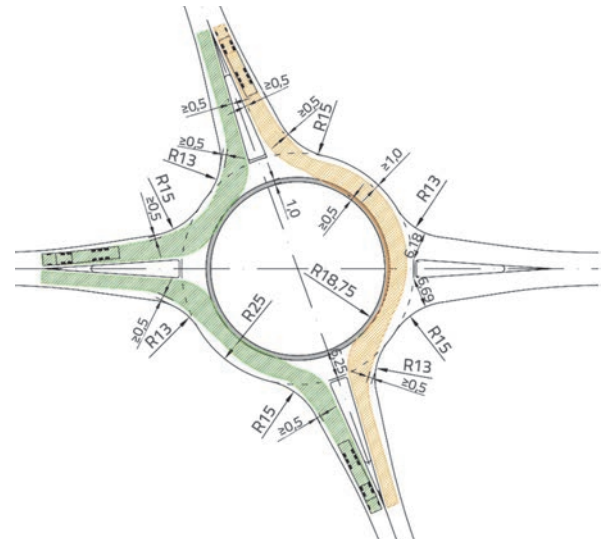

Figure 10. Roundabout designed according to Croatian guidelines [15]

In order to ensure an unobstructed passage of the design vehicle at roundabouts designed according to the Croatian guidelines [15], the outer roadway edges at all approaches are designed with a longer effective length of roadway widening (l'). Because of that, entrance and exit widths varied. In addition, at these roundabouts, truck aprons are designed with the width of 1.0 m (Figure 10).

At roundabouts designed according to German guidelines [17, 18], roadway edges on all approaches are parallel with the sides of the splitter island (Figure 11). In order to ensure an unobstructed passage of the design vehicle, the lane width at all entrances (B_2) is 4.5 m, while it is 5.25 at all exits (B_A) (Figure 11). German guidelines [17, 18] do not provide details on how to form the outer roadway edges in the transition area, between the open stretch of the road and the part along the splitter island (Figure 3).

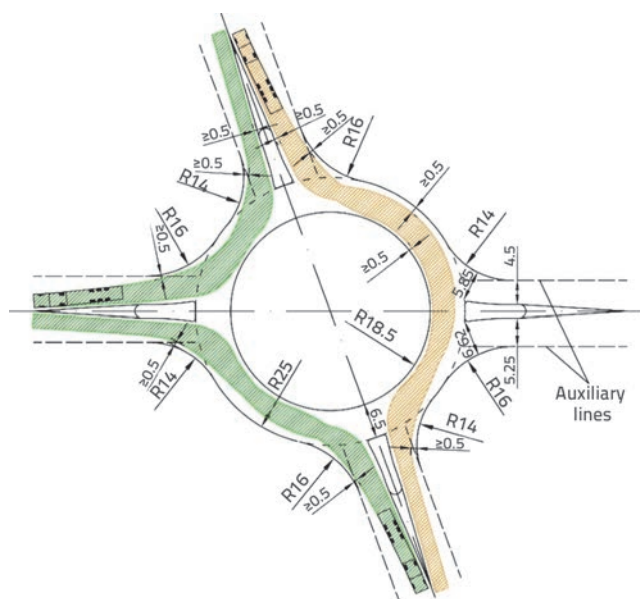

Figure 11. Roundabout designed according to German guidelines [17, 18]

The widening length (l'), entry angle (Φ), and widening severity (S), were examined for roundabouts designed according to Croatian guidelines [15], while the achieved deflection was examined for roundabouts designed according to German guidelines [17, 18].

5. Research results

The following results were obtained for roundabouts designed according to Croatian guidelines [15], (Tables 3 and 4):

- out of 30 initial schemes only 18 meet the initial design requirements, i.e. unobstructed passage of design vehicle, and application of outer roadway edges designed with three consecutive arcs;
- increase in the number of schemes with skewed intersection angle that meet design requirements is proportional to the increase of the outer radius;

- entrance widths (e) depend on the approach intersection angle and are proportional to the size of the outer roundabout radius (R_v): measured values range from 4.60 to 6.18 m, which is in accordance with recommended values (Table 1);
- exit widths (e') are greater than entrance widths, they depend on the approach intersection angles and are proportional to the size of the outer roundabout radius (R_v): measured values range from 5.86 to 6.69 m, which is in accordance with recommended values (Table 1);
- entrance radii (R_{ul}) range from 10.0 to 13.0 m;
- exit radii (R_{iz}) range from 13.0 to 15.0 m;
- calculated widening severities (S) range from 0.23 to 1.10, and are in accordance with recommended values from Table 1;
- measured entry angles (Φ) range from 40.10 to 48.43° and are mostly larger than the values recommended in Table 1, but are still within the limit values recommended by the guidelines.

The following results were obtained for roundabouts designed according to German guidelines [17, 18], (Tables 3 and 4):

- out of 30 initial schemes only 17 meet initial design requirements, i.e. unobstructed passage of design vehicle, and application of outer roadway edges designed with three consecutive arcs;
- out of 17 roundabouts that meet initial design requirements, the deflection criterion is fulfilled on 15 roundabouts (on roundabouts with the outer radius of 17.5 m the deflection is smaller than $2B_z$);
- increase in the number of schemes with skewed intersection angle that meet the design requirements is proportional to the increase of the outer radius;
- entrance widths (e) depend on the approach intersection angle and are proportional to the size of the outer roundabout radius ($D/2$): measured values range from 5.22 to 5.85 m;
- exit widths (e') are greater than entrance widths, they depend on the approach intersection angles and are proportional to the size of the outer roundabout radius ($D/2$): measured values range from 5.89 to 6.62 m;

Table 3. Roundabout schemes that meet design requirements

Intersection angles [°]	Croatian guidelines					German guidelines				
	Rv [m]					D/2 [m]				
	15.0	17.5	20.0	22.5	25.0	15.0	17.5	20.0	22.5	25.0
65/115	-	-	-	-	+	-	-	-	-	+
70/110	-	-	-	+	+	-	-	-	+	+
75/105	-	-	+	+	+	-	-	+	+	+
80/100	-	-	+	+	+	-	-	+	+	+
85/95	-	+	+	+	+	-	-	+	+	+
90/90	+	+	+	+	+	-	-	+	+	+

Note: + appropriate design is possible; - appropriate design is not possible

Table 4. Design elements on analysed roundabout schemes

Guidelines	Design element (Figures 3, 10 and 11)	Outer radii ($R_v = D/2$ [m])				
		15.0	17.5	20.0	22.5	25.0
Croatian	Entrance width (e) [m]	4.60	5.22	5.32	5.55	6.18
	Exit width (e') [m]	5.86	6.04	6.25	6.45	6.69
	Entrance radius (R _{ul}) [m]	10.0	13.0	13.0	13.0	13.0
	Exit radius (R _{iz}) [m]	13.0	15.0	15.0	15.0	15.0
	Widening severity (S) [-]	0.23	0.48	1.01	1.10	0.54
	Entry angle (Φ) [°]	40.10	42.33	44.07	45.58	48.43
German	Entrance lane width (B _z) [m]	-	4.5	4.5	4.5	4.5
	Entrance width (e) [m]	-	5.22	5.46	5.67	5.85
	Exit lane width (B _A) [m]	-	5.25	5.25	5.25	5.25
	Exit width (e') [m]	-	5.89	6.16 (6.21)	6.40	6.62
	Entrance radius R _z [m]	-	14.0	14.0	14.0	14.0
	Exit radius R _A [m]	-	16.0	16.0 (16.5)	16.0	16.0
	Deflection/B _z [-]	-	1.93	2.60	3.15	3.71

(values in brackets) - only for intersection angle of 75°

Table 5. Length of circular arc between entrance and exit radii

Intersection angles [°]	Croatian guidelines					German guidelines				
	R _v [m]					D/2 [m]				
	15.0	17.5	20.0	22.5	25.0	15.0	17.5	20.0	22.5	25.0
65	-	-	-	-	0.29	-	-	-	-	0.56
70	-	-	-	0.82	2.47	-	-	-	0.58	2.75
75	-	-	0.46	2.78	4.65	-	-	0.15	2.54	4.93
80	-	-	2.21	4.75	6.83	-	-	2.03	4.51	7.11
85	-	1.14	3.95	6.71	9.01	-	1.22	3.77	6.47	9.29
90	0.99	2.67	5.70	8.67	11.20	-	2.88	5.52	8.44	11.51

- entrance radii (R_z) are 14.0 m;
- exit radii (R_A) range from 16.0 to 16.5 m;

Length of the circular arc between the end of the entrance radius and beginning of the exit radius depends on the approach intersection angle, the size of the roundabout outer radius, and the size of the entry and exit radii (Table 5). According to Croatian guidelines [15], the length of this arc should be larger than 0 m (Figure 1.b).

6. Discussion

Guidelines that are analysed in this paper are based on the same roundabout-design approach that involves selection of roundabout size and approach alignment, design of central and splitter islands, roadway widths, and roadway edges. This is followed by swept path analysis for the selected design vehicle and by subsequent correction of design elements. The main difference between the considered guidelines is in the definition of roadway width (entrance,

exit, and circulatory) and in the outer roadway edges design on roundabout approaches.

Research results show that a considerable number of analysed roundabout schemes do not meet design and safety criteria for the selected design vehicle (16.5 m long semi-trailer truck), and that the design limits for approach angles depend primarily on the outer radius of the roundabout. Overall, a larger number of roundabout varieties can be derived using recommendations contained in Croatian guidelines [15]. This is the consequence of the procedure used for forming entry and exit roadway edges (with different effective widening lengths) which, combined with entrance and exit radii, resulted in larger lane widths and better adjustment to the design vehicle movement trajectories.

It can also be noted that the deflection criterion from German guidelines [17] is not affected by the deviation of approach intersection angles from the right angle, if the approach axes intersect at the geometric centre of the central island. In that case, the fulfilment of this criterion fully depends on the outer radius of the roundabout, on the

entrance and circulatory roadway widths, and on the width of the splitter island. If the roundabout approach axes do not intersect at the geometric centre of the central island, an increase or decrease of deflection around the central island will occur, if the angle between them deviates from the right angle.

The length of circular arc of the outer circulatory roadway edge between the end of entrance radius and the beginning of exit radius was also measured (Table 5). Results show significant differences between the designed roundabouts: the arc length ranges from 0.46 to 11.20 m at roundabouts designed according to Croatian guidelines [15], and from 0.15 to 11.51 m at roundabouts designed according to German guidelines [17].

7. Conclusions

Despite the fact that construction of intersections with skewed alignment is often required on road networks, earlier research studies do not provide description of roundabout design elements for these non-standard (and often unfavourable from the design point of view) approach alignments.

Research results presented in this paper show that the number of possible combinations of approach angles and outer radii enabling an unobstructed passage of the analysed design vehicle is rather limited, and that the design limits for these angles depend primarily on the outer radius of the roundabout. The main reason for this stems from geometric design of entrance and exit roadway edges on roundabout approaches, and from the predefined criterion that roadway edges between the neighbouring approach legs must be constructed from three circular arcs (i.e. entrance and exit roadway edges are designed curvilinearly tangential to the outside edge of the circulatory roadway).

Overall, design guidelines found in Croatian [15] and German [17, 18] documents result in similar number of roundabout schemes that meet requirements for safe and unobstructed passage of the selected design vehicle. Better adjustment of geometric elements to design-vehicle movement trajectories on roundabouts designed according to Croatian guidelines [15] shows that these guidelines are slightly more flexible in terms of roundabout design parameters. However, this is only true for roundabouts with the outer radius of 15 and 17.5 meters.

REFERENCES

- [1] Guichet, B.: Evolution of Roundabouts in France and new uses, National Roundabout Conference 2005, TRB, Colorado, 2005.
- [2] Baranowski, B.: History of the modern roundabout. Roundabouts USA, www.roundaboutsusa.com 10.10.2016.
- [3] Omazić, I.: Kružna raskrižja - suvremeni način rješavanja prometa u gradovima, e-gfos, br.1, 2010., pp. 54 – 66
- [4] NATIONAL COOPERATIVE HIGHWAY RESEARCH PROGRAM (NCHRP), Report 572: Roundabouts in the United States, TRB, Washington, D.C., 2007.
- [5] Pilko, H., Mandžuka, S., Barić, D.: Urban single-lane roundabouts: A new analytical approach using multi-criteria and simultaneous multi-objective optimization of geometry design, efficiency and safety. Transportation research part c-emerging technologies. 80 (2017), pp. 257-271, <https://doi.org/10.1016/j.trc.2017.04.018>
- [6] Brilon, W.: Studies on Roundabouts in Germany: Lessons Learned, 3rd International TRB-roundabout Conference, Carmel, Indiana, May 2011.
- [7] Tollazzi, T., Rencelj, M., Turnsek, S.: Slovenian experiences with alternative types of roundabouts - "turbo" and "flower" roundabouts, The 8th International Conference "Environmental Engineering" May 19–20, 2011.
- [8] Tollazzi, T., Rencelj, M.: Modern and alternative types of roundabouts – state of the art. 9th International Conference on Environmental Engineering, May 22–24, 2014 Vilnius, LITHUANIA, <https://doi.org/10.3846/enviro.2014.137>
- [9] Fortuijn, L.G.H.: Turbo Roundabouts: Design Principles and Safety Performance. Transportation Research Record: Journal of the Transportation Research Board, 2096 (2009), <https://doi.org/10.3141/2096-03>
- [10] Džambas, T., Ahac, S., Dragčević, V.: Design of Turbo Roundabouts Based on the Rules of Vehicle Movement Geometry. Journal of transportation engineering. 143 (2016) 7, pp. 1-10. [https://doi.org/10.1061/\(ASCE\)TE.1943-5436.0000850](https://doi.org/10.1061/(ASCE)TE.1943-5436.0000850)
- [11] Mauro, R., Branco, F.: Comparative Analysis of Compact Multilane Roundabouts and Turboroundabouts, Journal of Transportation Engineering-ASCE, 136 (2010) 4, pp. 284-296, [https://doi.org/10.1061/\(ASCE\)TE.1943-5436.0000106](https://doi.org/10.1061/(ASCE)TE.1943-5436.0000106)
- [12] Mauro, R., Cattani, M.: Potential accident rate of turboroundabouts, TRB 4th international symposium on Highway Geometric Design, Washington DC, Transportation research Board, 2010, Valencia, 2-5 June 2010.
- [13] Roundabouts – Application and design: A practical manual, (Dutch) Ministry of Transport, Public Works and Water management, Partners for Roads, 2009.
- [14] Hatami, H., Aghayan, I.: Traffic Efficiency Evaluation of Elliptical Roundabout Compared with Modern and Turbo Roundabouts Considering Traffic Signal Control. Promet-Traffic & Transportation. 29 (2017) 1, pp.1-11, <https://doi.org/10.7307/ptt.v29i1.2053>.
- [15] Smjernice za projektiranje kružnih raskrižja na državnim cestama, Građevinski fakultet Sveučilišta u Rijeci, Rijeka, srpanj 2014.
- [16] Plangleiche Knoten - Kreisverkehr, Österreichische Forschungsgesellschaft Straße-Schiene-Verkehr, (RVS 03.05.14), Wien, 2001.
- [17] Merkblatt für die Anlage von Kreisverkehren, Ausgabe 2006, Forschungsgesellschaft für Straßen- und Verkehrswesen (FGSV Verlag), Köln - FGSV 242
- [18] Richtlinien für die Anlage von Landstraßen (RAL), Ausgabe 2012. Forschungsgesellschaft für Straßen- und Verkehrswesen (FGSV Verlag), Köln 2012

- [19] TSC 03.341: 2011, Krožna križišča, Ministrstvo za infrastrukturo in prostor – Direkcija RS za ceste, Ljubljana 2011.
- [20] CROW: Eenheid in rotondes, CROW publication no. 126, Ede, Netherlands. 1998.
- [21] Maletin, M., Andjus, V., Katanić, J.: Tehnička uputstva za projektovanje površinskih raskrsnica (PGS-PR/07). Beograd, novembar 2010.
- [22] Vehicle Tracking: Integrated swept path analysis software. www.autodesk.com/products/vehicle-tracking/overview
- [23] American Association of State Highway and Transportation Officials (AASHTO) Green Book – A Policy on Geometric Design of Highways and Streets, AASHTO, Washington, D.C., 2004
- [24] Gattis, J.L., Low, S.T.: Intersection angles and the driver's field of view, Arkansas State Highway & Transportation Department, 1997.
- [25] Son, Y., Kim, S.G., Lee, J.K.: Methodology to Calculate Sight Distance Available to Drivers at Skewed Intersections Transportation Research Record n° 1796, 02-3487, Myong Ji University, Kyunggido, South Korea, Department of Transportation Eng., 2002, pp. 41-47.
- [26] Garcia, A.: Lateral Vision Angles and Skewed Intersections Design, Proc., 3rd International Symposium on Highway Geometric Design, Chicago, June 29-July 1, 2005.
- [27] Garcia, A., Belda-Esplugues, E.: Lateral Vision Angles in Roadway Geometric Design, Journal of Transportation Engineering, 133 (2007) 12, pp. 654-662, [https://doi.org/10.1061/\(ASCE\)0733-947X\(2007\)133:12\(654\)](https://doi.org/10.1061/(ASCE)0733-947X(2007)133:12(654))
- [28] Staplin, L., Lococo, K., Byington, S., Harkey, D.: Highway Design Handbook for Older Drivers and Pedestrians. Report No. FHWA-RD-01-103, Washington, D.C., USDOT, FHWA, 2001.
- [29] Tian et al.: Roundabout Geometric Design Guidance. Report No. F/CA/RI-2006/13. Division of Research and Innovation, California Department of Transportation, Sacramento, CA, June 2007.
- [30] Ahac, S.: Design of suburban roundabouts based on rules of vehicle movement geometry. Doctoral thesis, University of Zagreb, Faculty of Civil Engineering 2014.
- [31] Bemessungsfahrzeuge und Schleppkurven zur Überprüfung der Befahrbarkeit von Verkehrsflächen. Forschungsgesellschaft für Strassen und Verkehrswesen (FGSV Verlag), Köln, 2001.
- [32] Stančerić, I., Dobrica, T., Ahac, S., Dragčević, V., Tenžera, D.: Offtracking control requirements for quality roundabout design. Proceedings of the 3rd International Conference on Road and Rail Infrastructures (CETRA 2014), Road and Rail Infrastructure III, Lakušić, S. (editor). Zagreb: Department of Transportation, Faculty of Civil Engineering, 2014. 263-268.
- [33] Vlaović, F.: Oblikovanje izvangradskih kružnih raskrižja. Diplomski rad, Zagreb: Građevinski fakultet, 25.09. 2014, 143 str.
- [34] Directive 2002/77/EC of the European Parliament and of the Council of 18 February 2002 amending Council Directive 96/53/EC laying down for certain road vehicles circulating within the Community the maximum authorised dimensions in national and international traffic and the maximum authorised weights in international traffic, OJ L 67, 9.3.2002.